

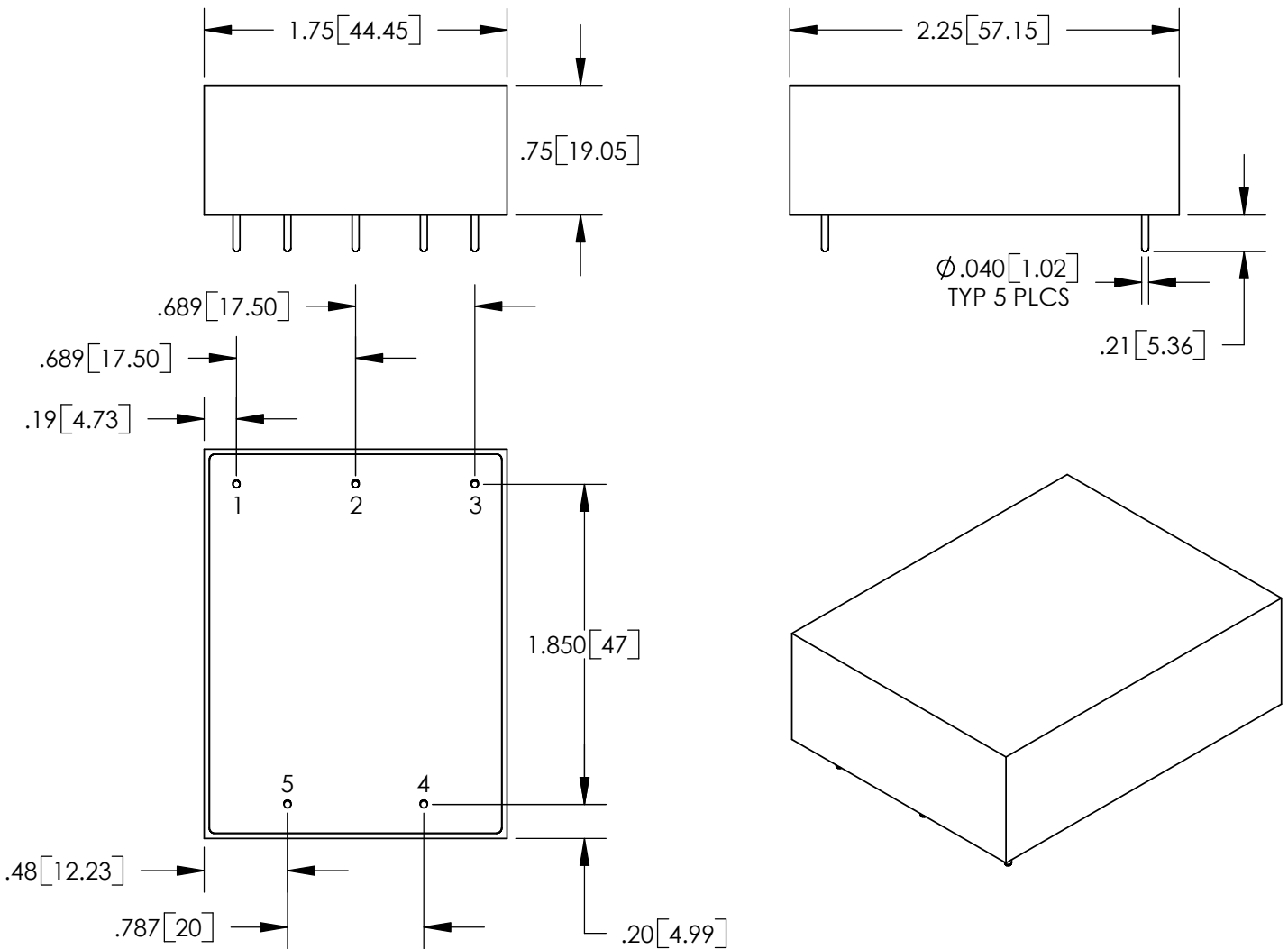

# MECHANICAL CONFIGURATION

## INDUSTRY STANDARD 5 WATT SINGLE OUTPUT



Dimensions are in inches [mm]

Tolerances: .XX +/- .02 [.50]  
.XXX +/- .010 [.250]

Case Material: Diallyl Phtalate

Construction: Epoxy Encapsulated

Pin #	Function
1	AC - Ground
2	AC - Neutral
3	AC - Line
4	+Vout
5	-Vout