

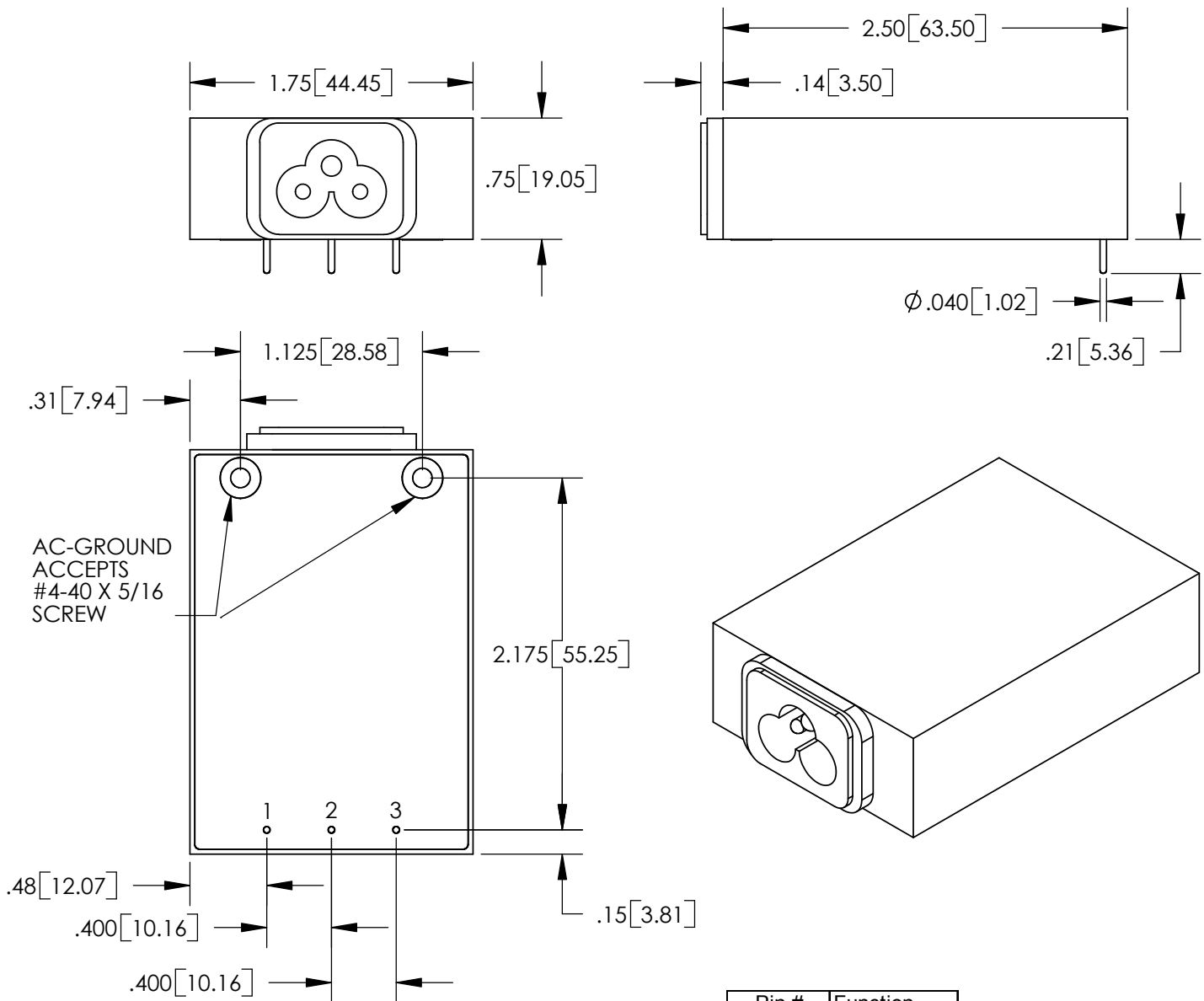

MECHANICAL CONFIGURATION

3 PIN AC INPUT
5 WATT SINGLE OUTPUT



Pin #	Function
1	Enable
2	-Vout
3	+Vout

Dimensions are in inches [mm]

Tolerances: .XX +/- .02 [.50]
.XXX +/- .010 [.250]

Case Material: Diallyl Phtalate

Construction: Epoxy Encapsulated