

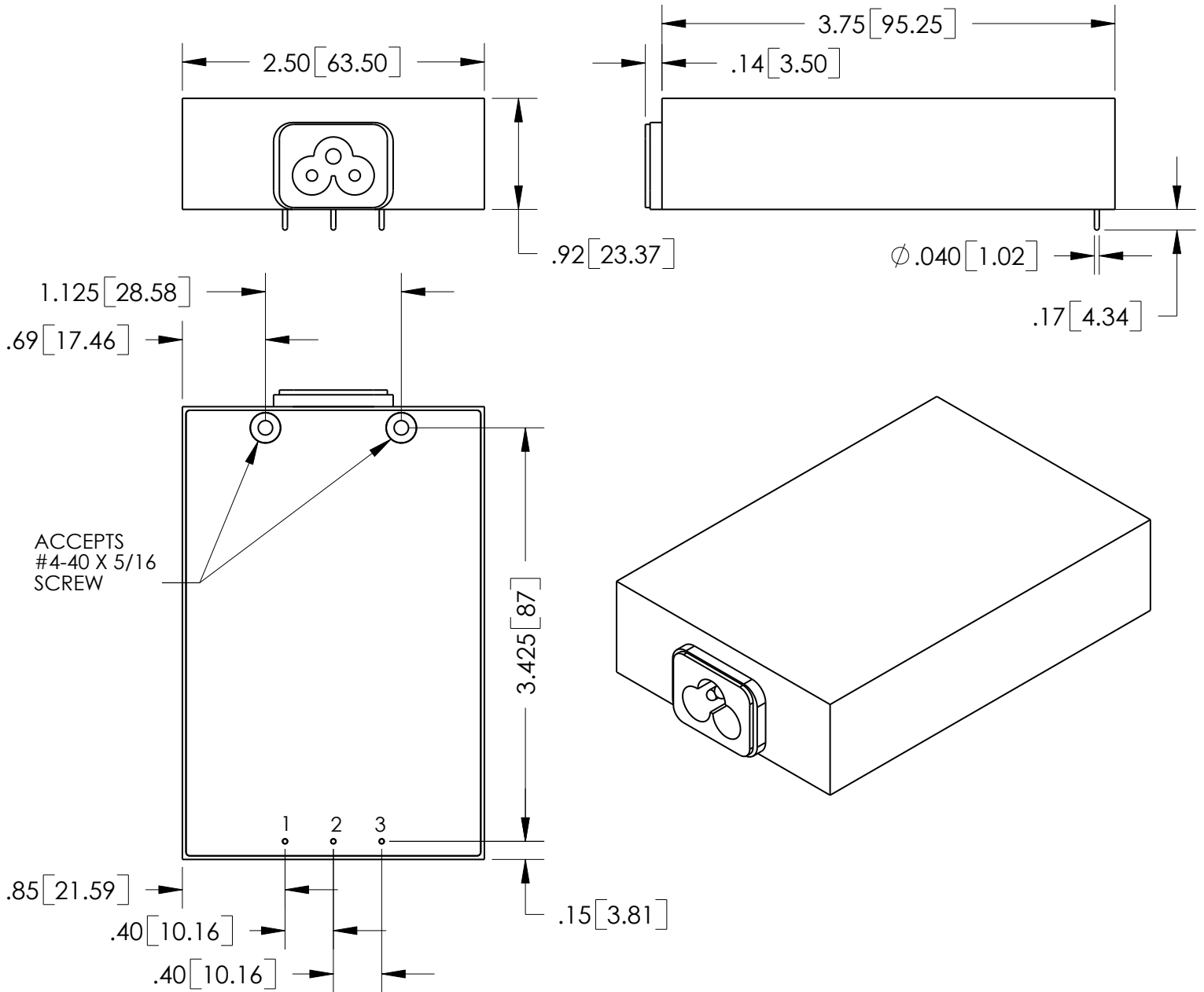

# MECHANICAL CONFIGURATION

3 PIN AC INPUT  
30 WATT SINGLE OUTPUT



Pin #	Function
1	Enable
2	-Vout
3	+Vout

Dimensions are in inches [mm]

Tolerances: .XX +/- .02 [.50]  
.XXX +/- .010 [.250]

Case Material: Diallyl Phtalate

Construction: Epoxy Encapsulated