

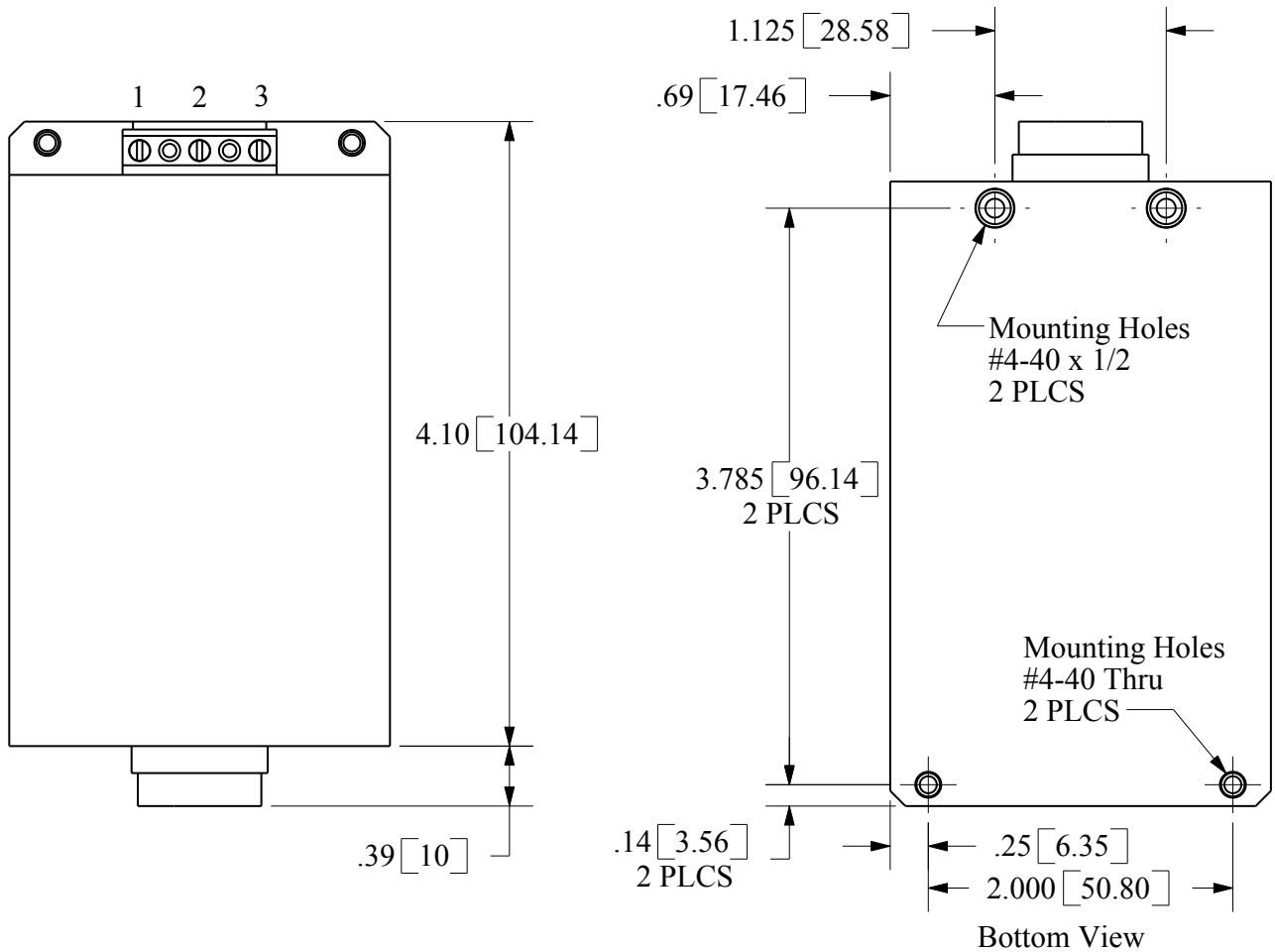

MECHANICAL CONFIGURATION

CHASSIS MOUNT -30 WATT SINGLE OUTPUT
2 PIN AC INPUT - TERMINAL BLOCK OUTPUT



Dimensions are in inches [mm]

Tolerances: .XX +/- .02 [.50]
.XXX +/- .010 [.250]

Case Material: Diallyl Phtalate

Construction: Epoxy Encapsulated

Web: www.bearpwr.com

Pin #	Function
1	Enable
2	-Vout
3	+Vout

Ph: 800-551-BEAR

Fax: 315-548-5100